

Wide ranging minimalist linear fixtures

A family of fixtures with minimalist styling and carefully crafted linear light distributions. Various options exist within the range for suspended, direct ceiling fix and wall mounting to suit a multitude of installation requirements.

- Multiple mounting options
- Housings - 100% recyclable T6061 aluminium.
- Outputs up to 4461 lm/m.
- Efficiency up to 122 lm/W.
- CRI 80 values.
- IP20 (indoor) environmental rating.
- Choice of fixed and tunable colour temperatures, in addition to RGBW colour mixing options.
- Low glare options delivered by recessed optics.
- Built-in or external drivers depending on model.
- DALI, DMX and non-dim control options.
- 3-hour battery-backed emergency lighting options available on all models. Options include: Battery backup; battery backup with self test indicator or battery backup with DALI integration to allow remote monitoring and testing.
- Fully CE compliant.

Please see page 10 for order options.

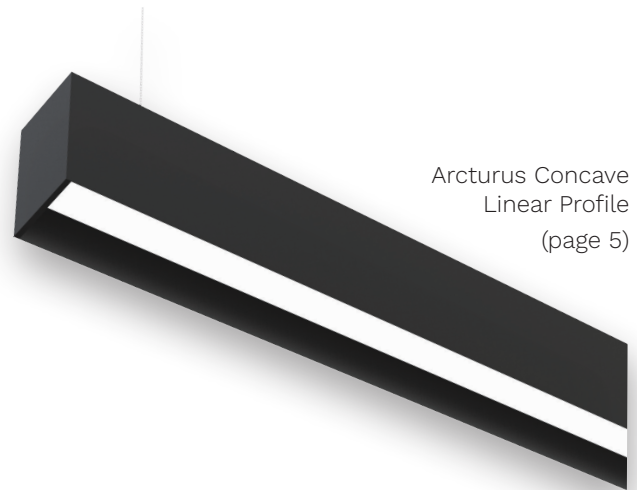

Arcturus Concave
Linear Profile
(page 5)

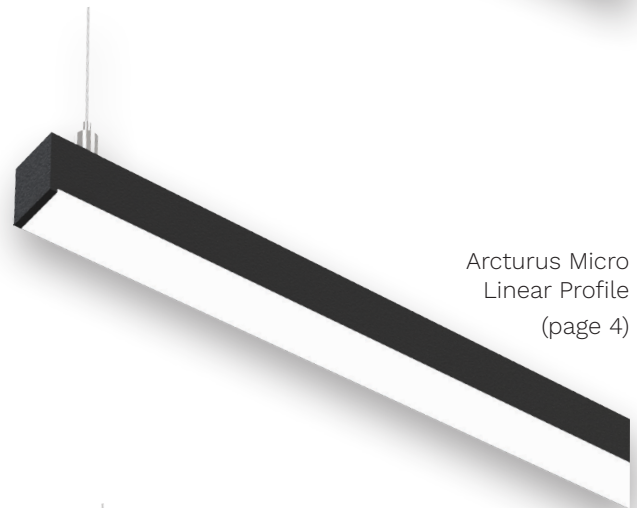

Arcturus Micro
Linear Profile
(page 4)

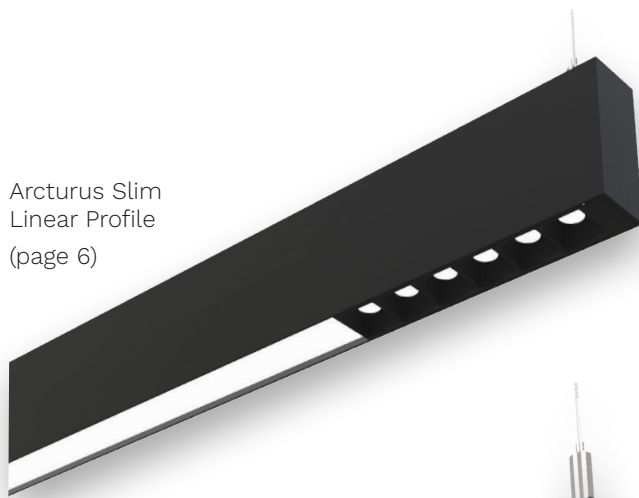

Arcturus Slim
Linear Profile
(page 6)

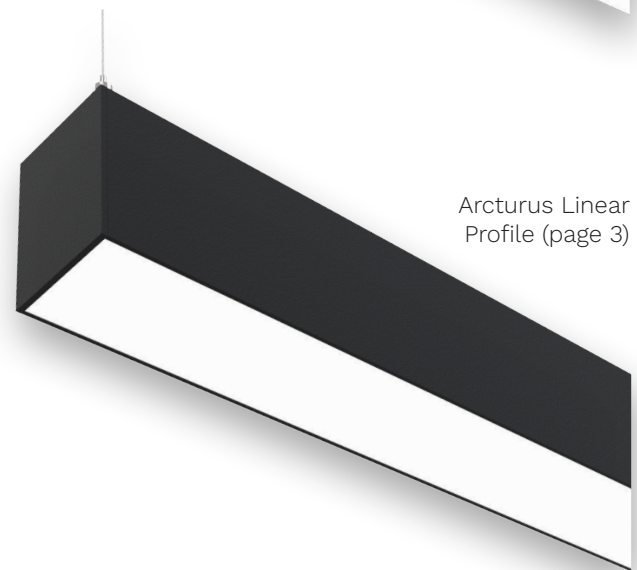

Arcturus Linear
Profile (page 3)

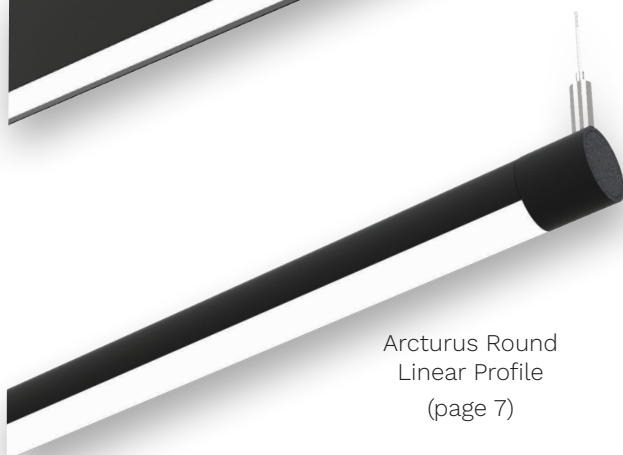

Arcturus Round
Linear Profile
(page 7)





continued overleaf

Arcturus Recessed Linear Profile (page 8)

Arcturus Wall Washer Linear Profile (page 9)



Multiple mounting options

	Linear Profile (page 3)	Micro Linear Profile (page 4)	Concave Linear Profile (page 5)	Slim Linear Profile (page 6)	Round Linear Profile (page 7)	Recessed Linear Profile (page 8)	Wall Washer Linear Profile (page 9)
Suspended 	<input checked="" type="checkbox"/>	<input checked="" type="checkbox"/>	<input checked="" type="checkbox"/>	<input checked="" type="checkbox"/>	<input checked="" type="checkbox"/>	<input type="checkbox"/>	<input type="checkbox"/>
Wall 	<input checked="" type="checkbox"/>	<input checked="" type="checkbox"/>	<input checked="" type="checkbox"/>	<input checked="" type="checkbox"/>	<input checked="" type="checkbox"/>	<input type="checkbox"/>	<input type="checkbox"/>
Ceiling surface 	<input checked="" type="checkbox"/>	<input checked="" type="checkbox"/>	<input checked="" type="checkbox"/>	<input checked="" type="checkbox"/>	<input type="checkbox"/>	<input type="checkbox"/>	<input type="checkbox"/>
Ceiling recessed 	<input type="checkbox"/>	<input type="checkbox"/>	<input type="checkbox"/>	<input type="checkbox"/>	<input type="checkbox"/>	<input checked="" type="checkbox"/>	<input checked="" type="checkbox"/>

Arcturus Linear Profile

This model is available in suspended, wall or surface mounted variants, each with a profile width of 62mm. LED source options include a choice of CCTs, tunable white and colour-changing RGB+White. Multiple driver types (non-dim, DALI or DMX) are available and reside within the fixture body. A low UGR<19 option with a prismatic lens is also available.

Specifications

Emitter options	Output (lm/m)	Power (W/m)	Efficacy (lm/W)
Low	1299	13.4	97
Medium	2532	25	101
High	4183	44.6	94

Colour temps.	3000K or 4000K. Other options include: Tunable white and RGBW
Driver voltage	220-240VAC
CRI (Ra)	80
SDCM	3-step MacAdam ellipse
UGR	<19 with prismatic lens option
Lifetime	50,000 hours (L ₈₀)
IP rating	IP20
Driver options	Non-dim, DALI or DMX
Lengths available	0.6m, 0.8m, 1.0m, 1.2m, 1.4m, 1.6m, 1.8m, 2.0m, 2.5m or 3.0m
Emergency opts.	3-hour battery-back up; available with or without self test indicator or DALI integration
Warranty	5 years
Body finish	White, black or aluminium (other RAL colours on request)



Suspended mount variant



Direct



Direct & Indirect



Indirect

Wall and ceiling mount variant



Direct



Direct & Indirect



Indirect



Direct

Dimensions

Direct or indirect only

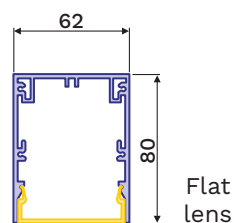

Flat lens

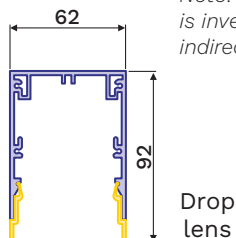

Drop lens

Note: Fixture is inverted for indirect-only

Direct plus indirect

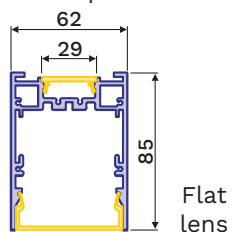

Flat lens

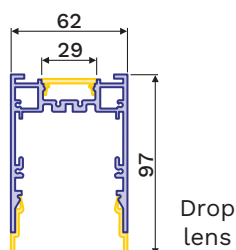

Drop lens

Polar chart

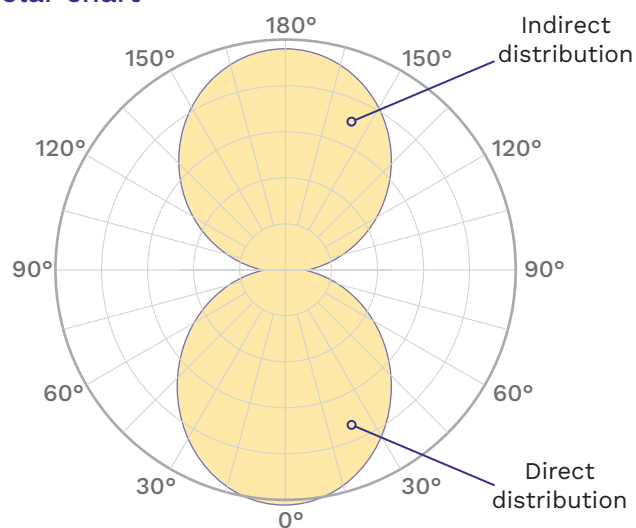

Arcturus Micro Linear Profile

This model is available in suspended, wall or surface mounted variants, each with a profile width of 25mm. LED source options include a choice of CCTs and colour-changing RGB+White. Multiple driver types (non-dim, DALI or DMX) are available and are external to the fixture.

Specifications

Emitter options	Output (lm/m)	Power (W/m)	Efficacy (lm/W)
Low	1080	13.4	81
Medium	2105	25	84

Colour temps.	3000K or 4000K. RGBW option also available
Driver voltage	220-240VAC
CRI (Ra)	80
SDCM	3-step MacAdam ellipse
Lifetime	50,000 hours (L ₈₀)
IP rating	IP20
Driver options	Non-dim, DALI or DMX
Lengths available	0.6m, 0.8m, 1.0m, 1.2m, 1.4m, 1.6m, 1.8m, 2.0m, 2.5m or 3.0m
Emergency opts.	3-hour battery-back up; available with or without self test indicator or DALI integration
Warranty	5 years
Body finish	White, black or aluminium (other RAL colours on request)

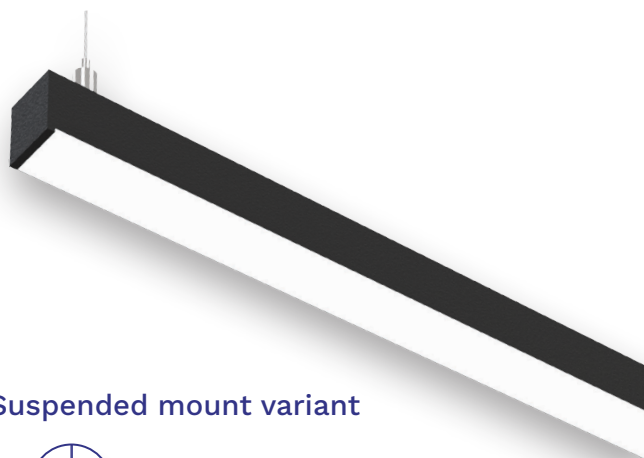

Suspended mount variant



Direct

Wall and ceiling mount variant



Direct



Indirect



Direct

Dimensions

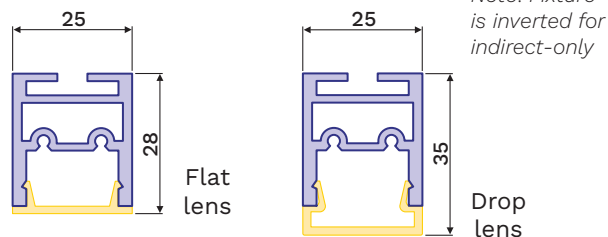

Polar chart

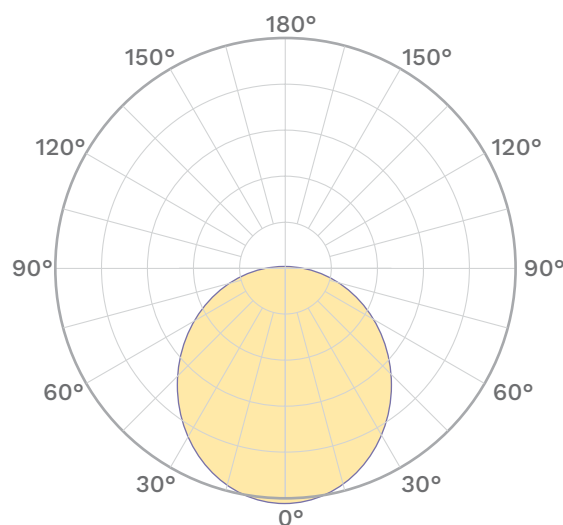

Arcturus Concave Linear Profile

This model is available in suspended, wall or surface mounted variants, each with a profile width of 50mm. LED source options include a choice of CCTs and colour-changing RGB+White. Multiple driver types (non-dim, DALI or DMX) are available and reside within the fixture body.

Specifications

Emitter options	Direct output (lm/m)	Indirect output (lm/m)	Efficacy Dir - Indir (lm/W)	Power Dir or Indir (W/m)
Low	889	1563	66 - 117	13.4
Med	1734	3046	69 - 122	25
High	2630	5033	59 - 113	44.6

Colour temps.	3000K or 4000K. RGBW option also available
Driver voltage	220-240VAC
CRI (Ra)	80
SDCM	3-step MacAdam ellipse
Lifetime	50,000 hours (L ₈₀)
IP rating	IP20
Driver options	Non-dim, DALI or DMX
Lengths available	0.6m, 0.8m, 1.0m, 1.2m, 1.4m, 1.6m, 1.8m, 2.0m, 2.5m or 3.0m
Emergency opts.	3-hour battery-back up; available with or without self test indicator or DALI integration
Warranty	5 years
Body finish	White, black or aluminium (other RAL colours on request)

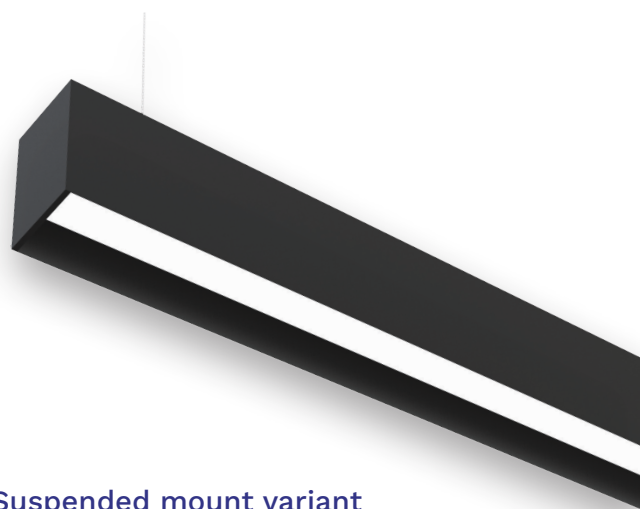

Suspended mount variant



Direct



Direct & Indirect

Wall and ceiling mount variant



Direct



Direct & Indirect



Indirect



Direct

Dimensions

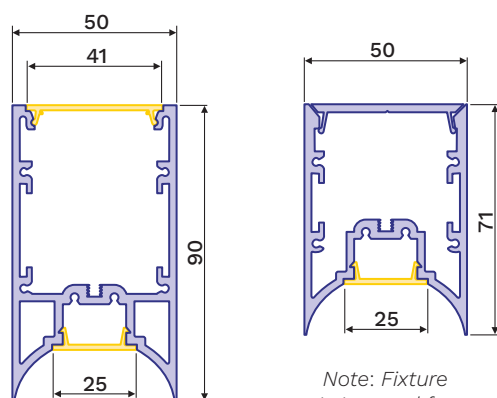

Polar chart

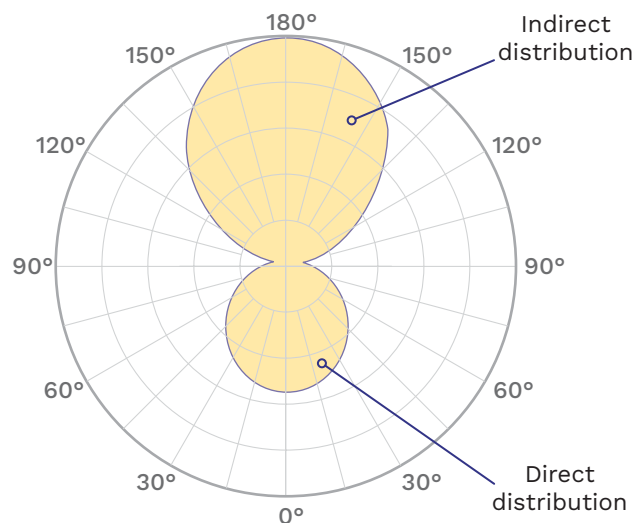

Arcturus Slim Linear Profile

This model has a profile width of just 33mm with direct and indirect illumination options, plus optional clusters of LED micro spotlights. LED source options include a choice of CCTs, tunable white and colour-changing RGB+White. Multiple external driver types (non-dim, DALI or DMX) are available.

Specifications

Emitter options	Direct output (lm/m)	Indirect output (lm/m)	Efficacy Dir - Indir (lm/W)	Power Dir or Indir (W/m)
Low	1128	1495	84 - 112	13.4
Med	2200	2602	88 - 104	25

Colour temps.	2700K to 4000K. Other options include: Tunable white and RGBW
Driver voltage	220-240VAC
CRI (Ra)	80
SDCM	3-step MacAdam ellipse
Lifetime	50,000 hours (L ₈₀)
IP rating	IP20
Driver options	Non-dim, DALI or DMX
Lengths available	0.6m, 0.8m, 1.0m, 1.2m, 1.4m, 1.6m, 1.8m, 2.0m, 2.5m or 3.0m
Emergency opts.	3-hour battery-back up; available with or without self test indicator or DALI integration
Warranty	5 years
Body finish	White, black or aluminium (other RAL colours on request)

Dimensions

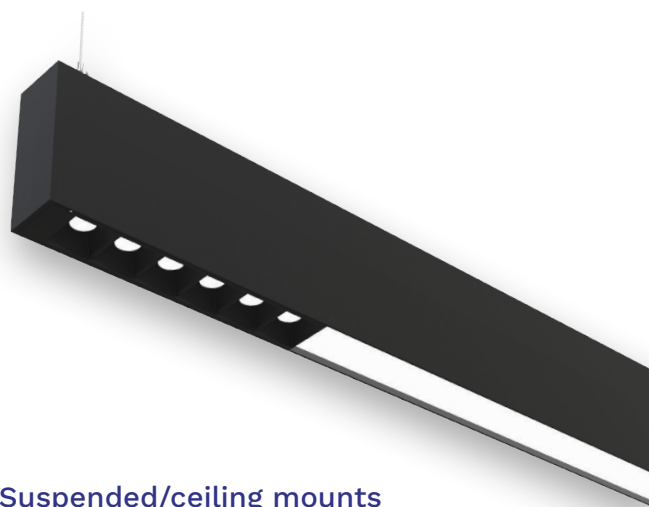
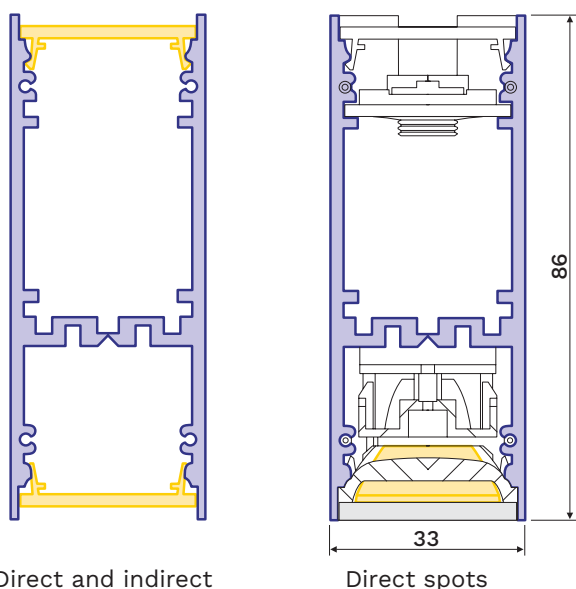

Suspended/ceiling mounts

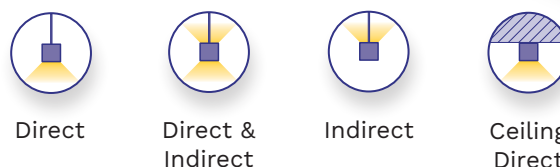

Optional spots

For additional direct illumination, clusters of 3 or 6 LED spots can be specified at each end. Spots are available with CCTs of 3000 or 4000K and also tunable CCT. Beam angles of 15°, 25° or 40° can be specified.

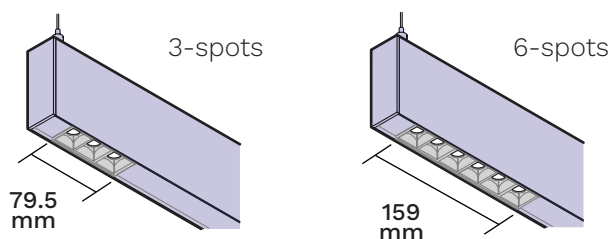

Polar chart (spots not included)

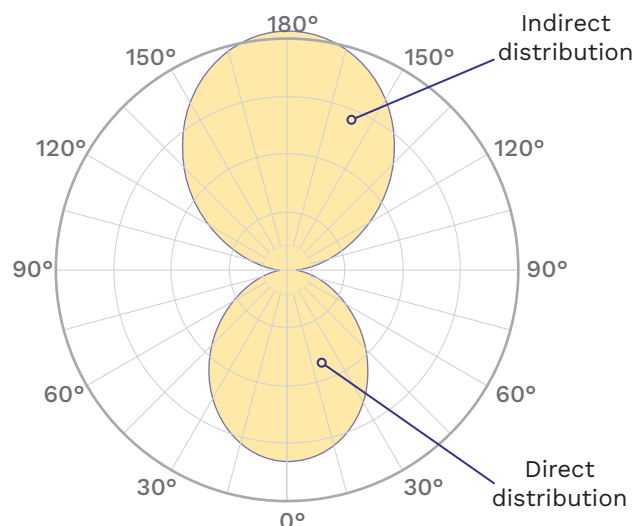

Arcturus Round Linear Profile

This model is available in suspended or wall mounted variants, each with a profile diameter of 30mm. LED source options include a choice of CCTs, tunable white and colour-changing RGB+White. Multiple driver types (non-dim, DALI or DMX) are available and are external to the fixture.

Specifications

Emitter options	Direct output (lm/m)	Indirect output (lm/m)	Efficacy Dir - Indir (lm/W)	Power Dir or Indir (W/m)
Low	1570	1570	117 - 117	13.4
Med	3061	3061	122 - 122	25

Colour temps.	2700K to 4000K. Other options include: Tunable white and RGBW
Driver voltage	220-240VAC
CRI (Ra)	80
SDCM	3-step MacAdam ellipse
Lifetime	50,000 hours (L ₈₀)
IP rating	IP20
Driver options	Non-dim, DALI or DMX
Lengths available	0.6m, 0.8m, 1.0m, 1.2m, 1.4m, 1.6m, 1.8m, 2.0m, 2.5m or 3.0m
Emergency opts.	3-hour battery-back up; available with or without self test indicator or DALI integration
Warranty	5 years
Body finish	White, black or aluminium (other RAL colours on request)



Suspended mount variant



Wall mount variant

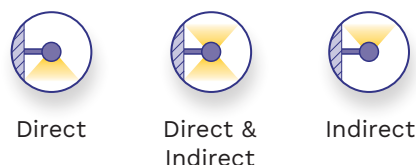

Dimensions

Direct and indirect

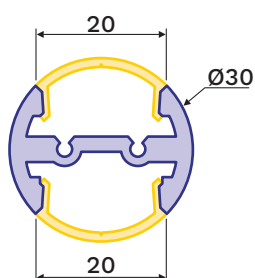

Indirect only

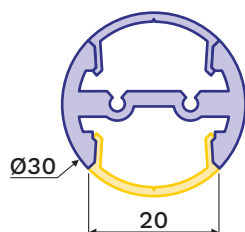

Note: Fixture is inverted for indirect-only

Polar chart

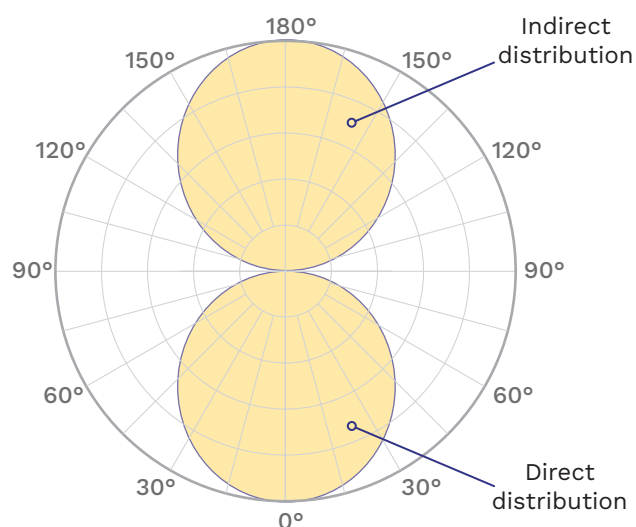

Arcturus Recessed Linear Profile

A low profile recessed variant, available with or without a visible edge trim. LED source options include a choice of CCTs, tunable white and colour-changing RGB+White. Multiple driver types (non-dim, DALI or DMX) are available and are external to the fixture.

Specifications

Emitter options	Output (lm/m)	Power (W/m)	Efficacy (lm/W)
Low	1385	13.4	103
Medium	2700	25	108
High	4461	44.6	100

Colour temps.	3000K or 4000K. Other options include: Tunable white and RGBW
Driver voltage	220-240VAC
CRI (Ra)	80
SDCM	3-step MacAdam ellipse
Lifetime	50,000 hours (L ₈₀)
IP rating	IP20
Driver options	Non-dim, DALI or DMX
Lengths available	0.6m, 0.8m, 1.0m, 1.2m, 1.4m, 1.6m, 1.8m, 2.0m, 2.5m or 3.0m
Emergency opts.	3-hour battery-back up; available with or without self test indicator or DALI integration
Warranty	5 years
Body finish	White, black or aluminium (other RAL colours on request)



Ceiling mount variant



Direct

Dimensions

Trimless

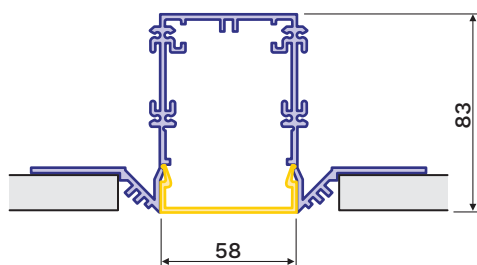

With trim

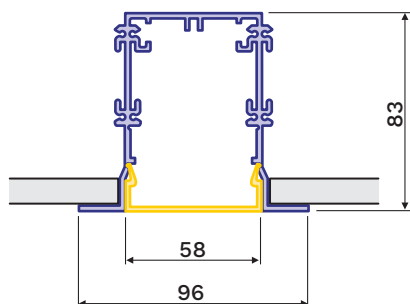

Polar chart

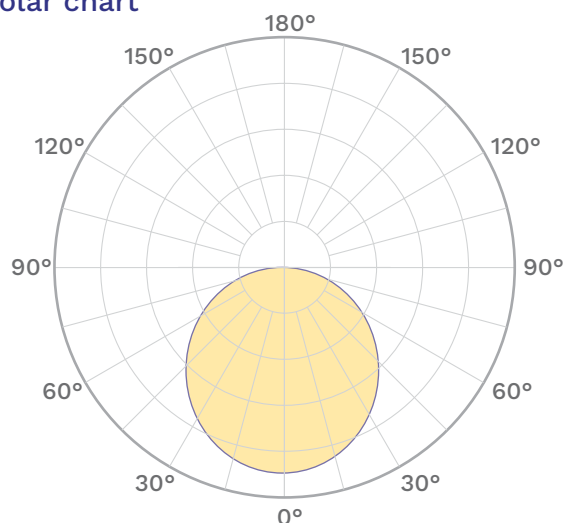

Arcturus Wall Washer Linear Profile

An ultra low profile recessed variant designed with the sole purpose of washing adjacent wall surfaces with quality illumination. LED source options include a choice of CCTs and colour-changing RGB+White. Multiple driver types (non-dim, DALI or DMX) are available and are external to the fixture.

Specifications

Emitter options	Output (lm/m)	Power (W/m)	Efficacy (lm/W)
Low	1010	13.4	75
Medium	1970	25	79

Colour temps.	3000K or 4000K. RGBW option also available
Driver voltage	220-240VAC
CRI (Ra)	80
SDCM	3-step MacAdam ellipse
Lifetime	50,000 hours (L ₈₀)
IP rating	IP20
Driver options	Non-dim, DALI or DMX
Lengths available	0.6m, 0.8m, 1.0m, 1.2m, 1.4m, 1.6m, 1.8m, 2.0m, 2.5m or 3.0m
Emergency opts.	3-hour battery-back up; available with or without self test indicator or DALI integration
Warranty	5 years
Body finish	White, black or aluminium (other RAL colours on request)



Ceiling mount variant



Direct

Dimensions

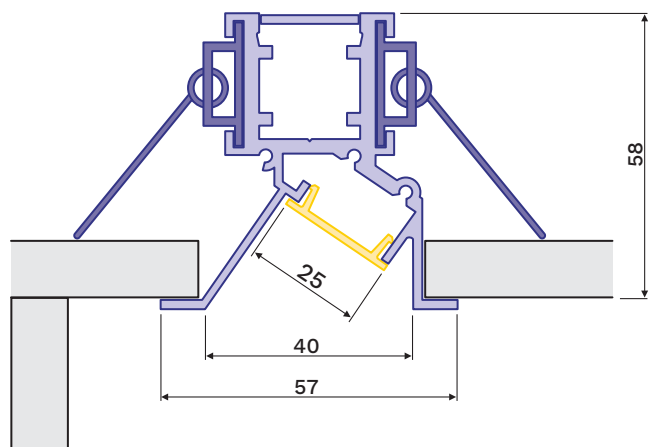

Polar chart

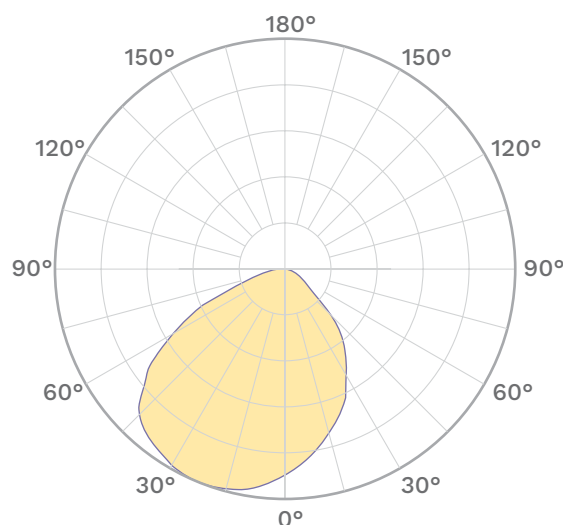

Standard order options

The table below indicates the options that are available across the Arcturus range. Please contact the GDS sales department or use the GDS website to determine the correct order code for your choice of options.

Range	Family	Variant	Mounting	Output	CCT	Output	CCT	Driver	Emergency	Shape	Length				
Reality	Arcturus	Linear Profile Micro LP Concave LP Slim LP Recessed LP Wall Washer LP Round LP	Suspended Wall Ceiling	Low	3000K	Low	3000K	NonDim DALI DMX	None 3hrs Emergency 3hrs Emergency Self-Contained	Straight or Shaped (see below)	0.6				
											Med	4000K	Med	4000K	0.8
											T/Low		T/Low		1.0
											T/Med		T/Med		1.2
											RGBW		RGBW		1.4
											RGBW		RGBW		1.6
									Direct Output (if required)		Indirect Output (if required)		1.8		
													2.0		
													2.5		
													3.0		
													(metres)		

Special-order shape configurations

Available on certain Arcturus variants:

- Linear Profile,
- Concave Linear Profile,
- Slimline Linear Profile.

Append this matrix to the main order code shown above. Shapes and lengths are demonstrated below:

Shape	Length A (metres)	Length B (metres)	Length C (metres)
Square			
Rectangle			
L-Left			
L-Right			
Cross			
T-Shape			
U-Shape			
Zed-Left			
Zed-Right			

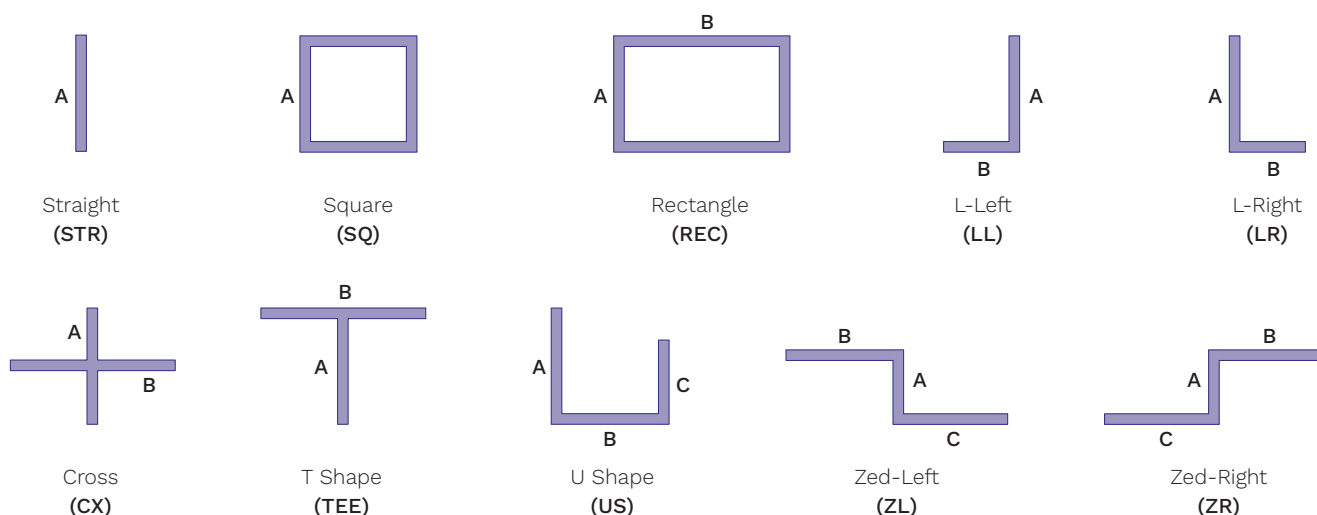

Note: All shapes are determined as viewed looking down from above.